

Features

- Compact design with waterproof kit included
- Superior conducted attenuation performance
- Screw mount
- Current rating 1A~10A
- IP65 acc. to IEC 60529 against liquids or mist

Marketing Applications

- Medical device (not body-coupled)
- Surveillance system
- EDP system
- Measuring instruments
- Infusion pump

Numbering System

1 SS3 **2** - **3** **4** **5** **6** **7** - **8**

1 Rated current

01,02,04,06,10

2 Electrical schematic

Blank: standard

3 Additional schematic (optional)

A: high performance

4 Fuse holder

- 1: can be installed single fuse
- 2: can be installed dual fuses

5 Components value (refer Filter selection table)

S: Cx=0.1uF, Cy=2.2nF
U: Cx=0.1uF, Cy=0.47nF

6 Grounded choke (optional)

G: Lg= 100uH

7 Bleeder resistor (optional)

R: R= 1M ohm; 1/4W min.

8 Output connections (refer Output terminal)

Q: fast-on tab (6.3mm)

Electrical Schematic •

• Blank: standard

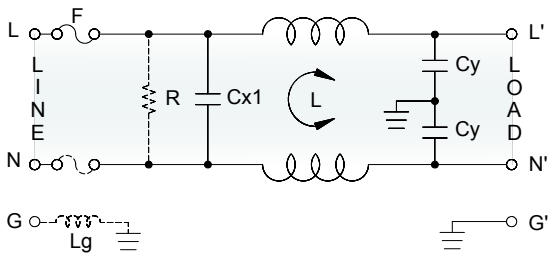

• A: high performance

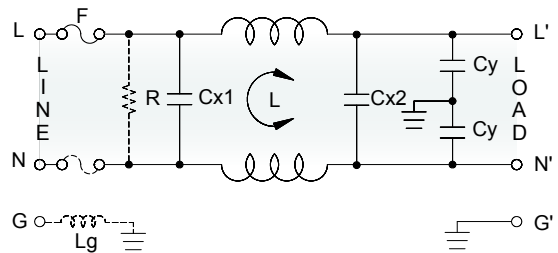

Filter Attenuation Insertion loss (dB) in 50 ohm system CISPR 17 (for reference only)

■ 1A~3A

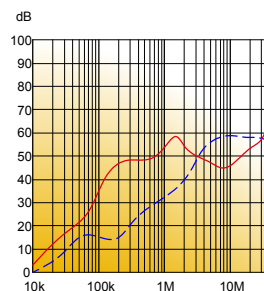

■ 4A~6A

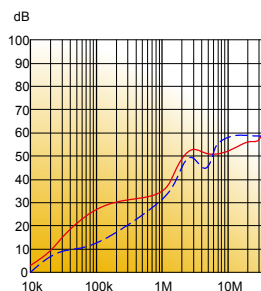

■ 8A~10A

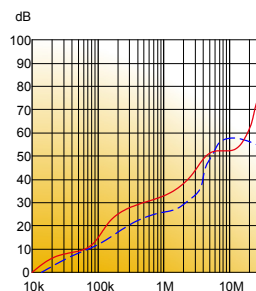

Common mode / Asymmetric (L-G) ————
Differential mode / Symmetric (L-L) - - - - -

Filter Selection Table •

Filter Part No.	Rated Current @50°C [A]	Leakage Current @250VAC/50Hz [µA]	Inductance @10KHz,0.25V [mH]	Capacitance			Output terminal	
				Cx1 [µF]	Cx2 [µF]	Cy [nF]		
Blank: standard								
01SS3-.S..	1	450	6.5	0.1	-	2.2	-Q	-W
02SS3-.S..	2	450	3.8	0.1	-	2.2	-Q	-W
04SS3-.S..	4	450	1.6	0.1	-	2.2	-Q	-W
06SS3-.S..	6	450	0.8	0.1	-	2.2	-Q	-W
10SS3-.S..	10	450	0.2	0.1	-	2.2	-Q	-W
01SS3-.U..	1	100	11	0.1	-	0.47	-Q	-W
02SS3-.U..	2	100	6.5	0.1	-	0.47	-Q	-W
04SS3-.U..	4	100	4.2	0.1	-	0.47	-Q	-W
06SS3-.U..	6	100	1.6	0.1	-	0.47	-Q	-W
10SS3-.U..	10	100	0.4	0.1	-	0.47	-Q	-W
A: high performance								
01SS3-A.S..	1	450	6.5	0.1	0.1	2.2	-Q	-W
02SS3-A.S..	2	450	3.8	0.1	0.1	2.2	-Q	-W
04SS3-A.S..	4	450	1.6	0.1	0.1	2.2	-Q	-W
06SS3-A.S..	6	450	0.8	0.1	0.1	2.2	-Q	-W
10SS3-A.S..	10	450	0.2	0.1	0.1	2.2	-Q	-W

Output Terminal (unit: mm)

- Q: fast-on tab based on UL310 standard

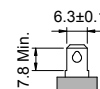

Mechanical Drawing (unit: mm)

- screw mount | waterproof IP65

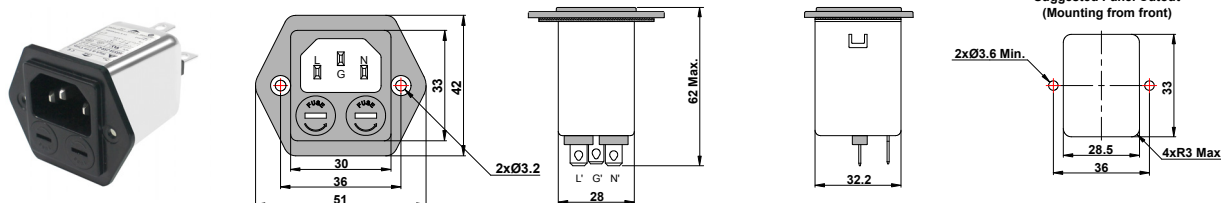

Installation instructions for waterproof kit

Waterproof kit (Item code: Part x Q'ty)

- A1: Silicon rubber sealing for filter.....x1
- A2: Silicon rubber sealing for fuse holder.....x6
- A3: Silicon rubber sealing for M3 screw.....x6

- A4: M3 screw.....x2
- A5: M3 nut.....x2
- A6: M3 washer.....x2

Step 1

Put A2 on the cover of fuse holder first. Install fuse(s) and put fuse holder back.

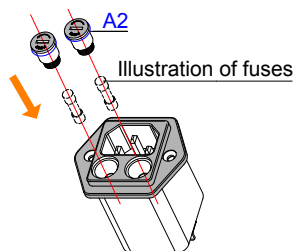

Step 2

Put A1 on the filter, then install the filter on panel.

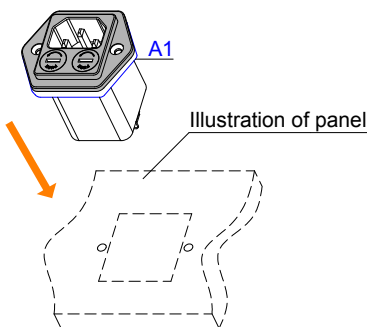

Step 3

Put A3 on A4 first, then install the A4. Install A6 and A5 on A4 from the rear of panel.

